

Your data:

Name: _____

Company: _____

E-Mail: _____

DIMENSION SHEET INNER INFLATABLE BELT

Please make a selection and enter it in the fields provided.

You Choose

Rubber-quality

amount:

 pcs

InnerØ- tube (mm)









height(mm)

Ø Max. blowing (mm)

inquiry
 order

- NK black 40° Shore
- NK white FDA 40° Shore
- EPDM <math><10^5 \Omega</math> 40° Shore
- Silicon Nature FDA 60° Shore



Other qualities on request

	Technical standard quality, wear-resistant, notch resistant	
	FDA-Quality Food safe	
	Electrically conductive antistatic	
	Temperature resistant (+230°C) FDA- Food sector	

Valves / Airconnector

- amount: pcs
- amount: pcs
- amount: pcs

Other connectors on request

	Fix connector for 6mm tube	R = 16 mm
	1/4 Zoll external thread	R = 21 mm
	V2A-tube Ø 6 x 200 mm long	R = 16mm

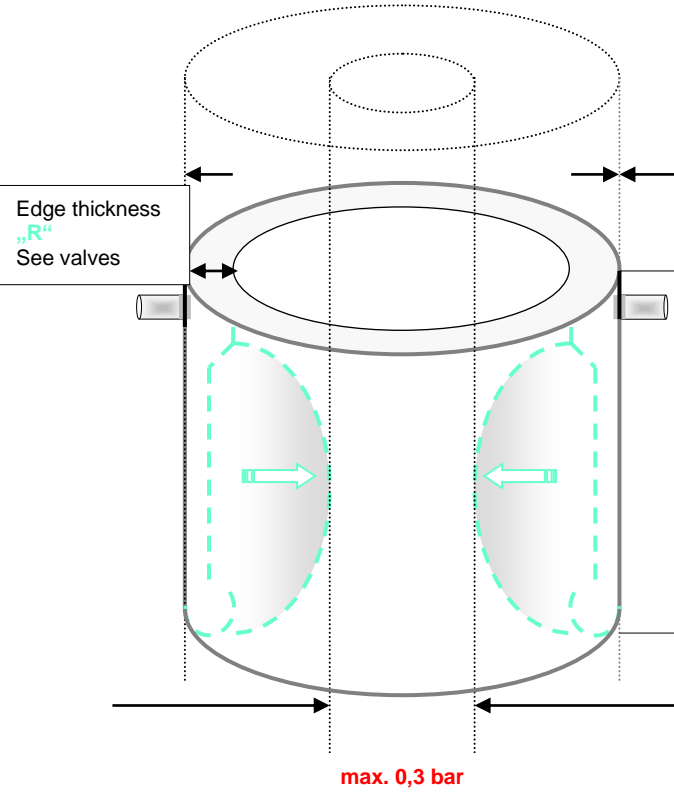

Franz-Wachter-Str. 28
70188 Stuttgart
anfrage@manfred-kunze.de
www.manfred-kunze.de